

ecoTEC plus

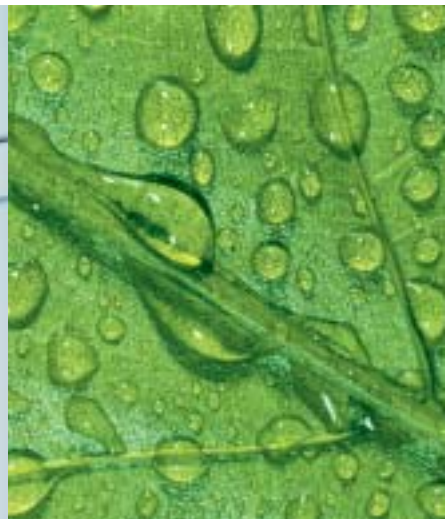

**New high efficiency
condensing combination
and system boiler ranges**



Simply high performance

With condensing boilers becoming ever more widely used the need for high performance products that can be relied upon with confidence has never been greater. Vaillant has responded with the new range of ecoTEC plus high efficiency condensing gas boilers.

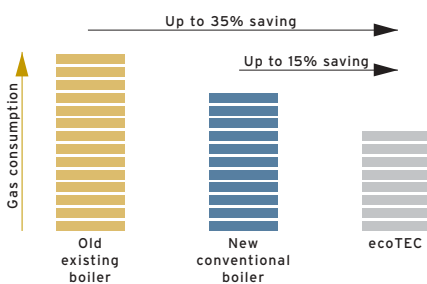
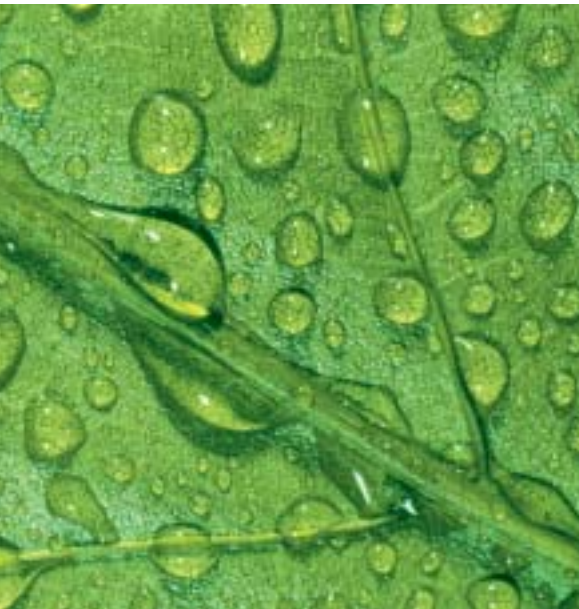

ecoTEC plus is the latest generation of high efficiency combination and system boilers from Vaillant and complements the existing ecoMAX range of products. As well as delivering the top SEDBUK band "A" rated fuel efficiency, they are combined with the quality, reliability and high performance expected from Vaillant products.

ecoTEC plus are the most compact combination and system boilers ever developed by Vaillant and, in conjunction with a host of features, provide simple installation and servicing together with unrivalled siting flexibility.

A wide range of both combination and system boiler models means that there is an ecoTEC plus for almost every application and furthermore they are all backed up with a full two year guarantee.†

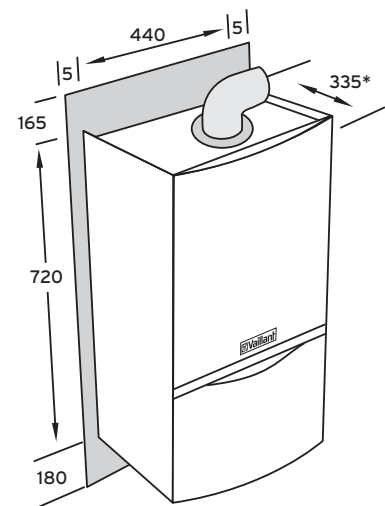

*369mm - ecoTEC plus 630



Energy Efficiency Recommended is an Energy Saving Trust initiative backed by the government. The logo is only found on products that have been carefully selected for their energy efficiency. Buy where you see the sign and help save energy, money and the environment.

†The 2 year guarantee covers against manufacturing defects and provides for the replacement of defective parts with new parts and any related labour costs, providing that such works are carried out by a Vaillant Engineer or Vaillant appointed agent. For the guarantee to be valid an annual service must be carried out by a CORGI registered installer. The cost of this annual service is not included in the guarantee.



Designed to make life easy

ecoTEC plus has been developed to satisfy the needs of installers, specifiers, service engineers and end users.

Clip distance pipework connections, built-in filling loop (combi models), simple electrical connections and plug-in controls together with a straightforward push fit fluing system all save installation time.

A comprehensive boiler display system showing status and diagnostic information along with a component layout designed for unrestricted access and rapid removal means that commissioning and subsequent servicing are all simplified.

High SEDBUK "A" efficiency rating and an enhanced "AquaComfort" system (combi models) provide low running costs for end users combined with superb hot water performance.

At home in any kitchen

ecoTEC plus boilers are all designed with a height of 720mm to match the height of a standard kitchen cupboard and feature a new high quality and stylish casing design. The compact dimensions, low lift weight and no requirement for air vents make ecoTEC plus boilers easy to fit, even in confined spaces. A wide range of flue accessories, including the innovative variable termination kit, make boiler siting easy.

All ecoTEC combi models also operate on low water pressures needing just 0.5 bar to achieve full flow rate and so are the ideal solution to low water pressure areas and multi-storey flats.

The ecoTEC plus range has a boiler for every application

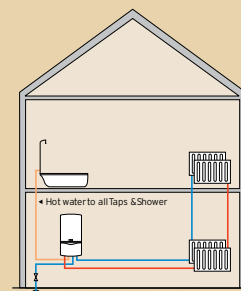

ecoTEC plus combination boiler

ecoTEC plus condensing combination boilers require no hot water cylinder or cold water storage tank.

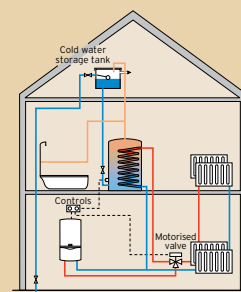

ecoTEC plus system boiler with vented cylinder

ecoTEC plus condensing system boilers have all major system components (pump, expansion vessel, bypass valve, automatic air vent) built-in.

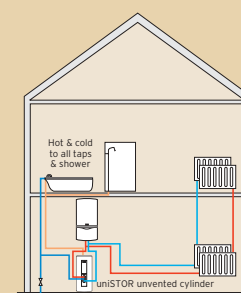

ecoTEC plus system boiler with unISTOR unvented cylinder

ecoTEC plus condensing system boilers with unISTOR unvented cylinder provide a harmonised boiler and cylinder system.

Quality and reliability

The inside story

For over 130 years Vaillant has been developing and supplying products that have shaped the heating industry. ecoTEC plus is the new benchmark for performance, quality and reliability.



The mark of quality for domestic heating

Vaillant is a member of the Benchmark initiative and fully supports the aims of the programme. Benchmark has been introduced to improve the standards of installation and commissioning of central heating systems in the UK and to encourage the regular servicing of all central heating systems to ensure safety and efficiency.

On ecoTEC combination boilers the 5 year anti-scale guarantee provides solely for the replacement of the Domestic Hot Water Heat Exchanger component in the event of lime scale blockage within 5 years from the installation date. The replacement must be carried out by a Vaillant Engineer or Vaillant appointed agent, and labour costs are not included in this guarantee.

2 year
guarantee

5 year
anti-scale
guarantee

on all Vaillant
combination boilers

Fully modulating low NOx burner

Automatically matching heat output to demand, achieves best class emissions within European standards



Domestic heat exchanger

Stainless steel construction with large surface area to provide rapid hot water delivery and efficient operation



Boiler display system

Provides comprehensive status and diagnostic information and simple push button programme for easy commissioning and servicing



Single electronic circuit board

Simplifies commissioning and servicing



'AquaComfort' system

Incorporates a warmstart facility to provide instantaneous hot water delivery with a special flow sensor which ensures constant hot water temperatures over a wide operating range (ecoTEC combi models)



Push-fit flueing

A wide range of flue options, all with push-fit connection provides total flexibility in siting



Main heat exchanger

High-performance, circular stainless steel heat exchanger allows more heat to be extracted by recapturing otherwise wasted heat



Motorised diverter valve

(ecoTEC combi models) with built-in automatic adjustable bypass



Automatic 2 speed pump

Automatically adapts to loading to ensure quiet operation and electrical energy saving



Built-in filling loop

For filling the central heating system (combi models)

Simple installation

and servicing

Every feature built into ecoTEC plus has been designed with ease of installation and servicing in mind.

Well connected

All system isolating valves are built into the boiler and are provided with compression fittings. All connections are provided with pre-formed copper pipework allowing connection at pipe clip distance from the wall; an optional spacer frame allows pipework to be run to above for top connections.

An automatic system bypass is also incorporated in the boiler, so there is no need to install and adjust a separate bypass. Straightforward plug and socket electrical connections have also been designed to make installation simpler.

A built-in filling loop for the central heating system saves the additional cost and labour of installing a remote fill point (combi models).

And well protected

To protect the boiler in freezing conditions a built-in 2 stage frost thermostat automatically operates the pump and if needed the burner, providing frost protection and minimising gas consumption. And a built in syphonic trap discharges condensate in fixed volumes guarding against disposal pipe freezing.

Simple to operate and commission

All boilers are factory set and checked, and require no adjustment allowing easier and faster commissioning.

All ecoTEC plus models feature a boiler display system which shows status and diagnostic information for easy commissioning and subsequent service work.

Normal mode

Displays boiler flow temperature

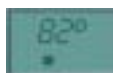

Status mode

For a quick functional check during commissioning



Fault mode

Highlights system problems at a glance (eg. F.28: no gas supply)



Diagnostic mode

Displays key component operating information

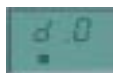

A drop down control box also provides easy access to all components, facilitating service work.



Optional controls and accessories

For use with ecoTEC plus and ecoTEC pro combination boilers.



the programmer also has an over-ride function, holiday function, adjustable set-back temperature and 3 room temperature profiles. A calendar function can be activated to provide automatic summer/winter changeover.



Weather compensator - VRC 400

This weather compensator offers the functionality and features of the VRT 360 with the additional benefit of weather compensation. An externally mounted temperature sensor monitors the outside temperature and modulates the boiler for greater fuel savings.



timeSWITCH 130

Plug-in timer for ecoTEC combination boilers provides 24 hour analogue control of central heating without the need for additional wiring.

timeSWITCH 140

(as shown in main image)
Plug-in digital programmer for ecoTEC combination boilers provides 24-hour or 7-day independent time control for both central heating and "AquaComfort" hot water system. When installed with a VR 65 control centre the programmer can be used to control both central heating and DHW in an ecoTEC plus system boiler and hot water cylinder installation.



Programmable room thermostat - VRT 360

This is a versatile and feature-packed digital control for ecoTEC condensing boilers. Provides 7-day or 24-hour independent time control for central heating and 'AquaComfort' (combination boilers). When installed with a VR 65 the second channel can be used to control the DHW in a system installation. A third time channel can be used for independent control of a separate device. With 3 independent time windows per day,



vrDIALOG 810 diagnostic software

This software enables fast and accurate boiler status assessment during routine appliance service or call-out. Operational parameter settings and faults can be easily diagnosed using simple easy to follow Windows-based interactive screens.

Delivered on CD-ROM with USB cable.
For use with all ecoTEC boilers only.

Note: ecoTEC boilers and all the above associated controls (excluding timeSWITCH 130) operate on a simple 2 wire low voltage 'ebus' system. This allows both boiler and control to communicate with each other. See 'Total System Solution' section for further details.

ecoTEC pro

The ecoTEC pro 28 combination boiler has the same high build quality as ecoTEC plus combi models but has a more basic specification.



Performance Checklist	ecoTEC plus combination 824/831	ecoTEC pro 28
Compact case	●	●
'AquaComfort' system	Comprehensive system	Simplified system
Built - in filling loop	●	-
Connections	Preformed pipe-clip distance tails	Rear facing connections
Status/Diagnostic system	Comprehensive boiler display system	Simplified boiler display system
Guarantee period	2 years	1 year
User controls concealed	●	-
Bottom cover	●	-
Condensate removal mechanism	Siphonic condensate discharge	Condensate trap
Pump	Automatic 2 speed	1 speed

Flues and flue accessories

Maximum flue lengths*	ecoTEC plus combi		ecoTEC pro combi	ecoTEC plus system				
	824	831	28	612	615	618	624	630
Standard horizontal 100mm diameter ¹	8	8	8	8	8	8	8	8
Standard vertical 100mm diameter ¹	12	12	12	12	12	12	12	12
Optional horizontal 125mm diameter ²	25	25	25	13	13	25	25	25
Optional vertical 125mm diameter ²	27	27	27	14	14	27	27	27

*Measured to the end of the horizontal /vertical terminal

1. This is the standard system for ecoTEC boilers. The maximum length must be decreased by 1 metre for each additional 87° elbow or pair of 45° bends.
2. This is an optional flue system for ecoTEC boilers where longer flue lengths are required. The maximum length must be decreased by 2.5 metres for each additional 87° elbow and 2 metres for each pair of 45° bends. Optional boiler flue outlet adaptor (accessory 303926) will be required.

High efficiency flue accessories	Standard 100mm Ø	Optional 125mm Ø
	Accy. Number.	Accy. Number.
Horizontal air/flue duct with elbow and terminal (754mm)	303933	N/A
Horizontal air/flue duct with elbow and terminal (1000mm)	N/A	303209
Boiler flue outlet adaptor (Ø100mm to Ø125mm)	N/A	303926
Horizontal telescopic air/flue duct	303936	N/A
Vertical air/flue duct and terminal	303900	303200
Flat roof penetration collar	009056	009056
Pitched roof adjustable roof tile	009076	009076
Flexible pitched roof seal	303980	303980
87° elbow	303910	303210
Two 45° bends	303911	303211
Air/flue duct extension (470mm)	303902	303202
Air /flue duct extension (970mm)	303903	303203
Air /flue duct extension (1970mm)	303905	303205
Telescopic air/flue duct extension (440-690mm)	303906	N/A
Telescopic offset	303919	N/A
Sliding sleeve	303915	303215
Flue support clips (box of 5)	303821	303616
Adjustable flue support clips (box of 3)	303935	N/A
Black terminal kit for horizontal air/flue duct	303934	N/A

High efficiency flue accessories



Horizontal air/flue duct with elbow and terminal

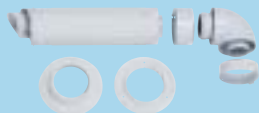

Horizontal telescopic air/flue duct



Variable Termination Kit (VTK)



Black terminal kit for horizontal air/flue duct | Adjustable flue support clips (box of 3) | Flexible pitched roof seal

Variable Termination Kit (VTK) and components

For use with Ø100mm flue only (303933 and 303936)

Description	Accy. Number
Variable Termination Kit - black	303942
VTK extension pipe 1m - black	303943
VTK 87 degree elbow - black	303944
VTK 45 degree bends (2 pcs) - black	303945
Variable Termination Kit - white	303946
VTK extension pipe 1m - white	303947
VTK 87 degree elbow - white	303949
VTK 45 degree bends (2 pcs) - white	303948

ecoTEC plus and pro boilers are room sealed fan assisted (RSF) appliances and can be installed with horizontal and vertical flues.

ecoTEC plus and pro boilers utilise the standard 100mm diameter concentric flue system. An optional larger 125mm diameter concentric flue system is available, where

longer flue lengths can be achieved if required (optional boiler flue outlet adaptor accessory number 303926 will be required).

All flues feature simple push-fit connections and a smart white finish.

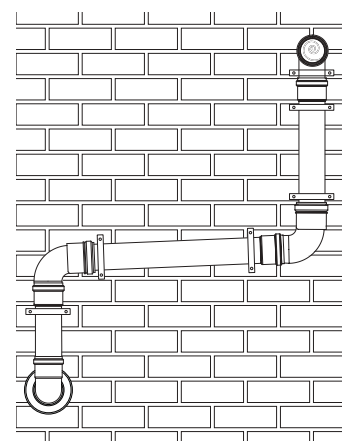

uniSTOR

unvented cylinders



uniSTOR is a new range of six high grade stainless steel unvented cylinders from Vaillant. Finished with a stylish casing they are available in a range of sizes from 125 litres to 310 litres. uniSTOR can be used with proprietary system boilers. However when installed with Vaillant boilers such as ecoTEC plus system boilers, a total heating and hot water solution is provided.

uniSTOR features a high recovery heating coil and insulation which exceeds CHeSS Best Practice. All seams are laser welded and the shell is backed up by a 25 year warranty.

- uniSTOR cylinders operate using a mains water pressure supply and do not require a feed from a cold water storage tank
- all necessary cold and hot water controls and a 2-port valve for control of domestic hot water are supplied
- all uniSTOR cylinders are backed by a full 2 year guarantee as well as a 25 year guarantee on the cylinder shell

Typical applications	
Single bathroom property	uniSTOR 125
Single bathroom property with an en-suite shower room	uniSTOR 125 / 155
Two bathroom property	uniSTOR 155 / 180
Two bathroom property with an en-suite shower room	uniSTOR 180 / 210
Larger properties	uniSTOR 260 / 310

Technical specification

uniSTOR stainless steel unvented cylinder		125	155	180	210	260	310
External case height	mm	938	1148	1308	1468	1758	2078
External case width	mm	602	602	602	602	602	602
External case depth	mm	554	554	554	554	554	554
Weight approx.	kg	28	30	33	39	44	49



Customer support services



The after sales service and support behind every Vaillant boiler is part of the quality package that has helped Vaillant to build a unique reputation within the industry.

- engineers on call 364 days a year, 7 days a week
- next working day call out policy
- feedback to installer for installer booked in-warranty calls
- end user courtesy telephone call post engineer visit

Extended opening hours :
Mon - Fri 8am - 8pm
Sat - Sun 9am - 4pm

For more details just call Vaillant Service on **0870 6060 777**.

Vaillant offers an extensive range of training courses at five fully equipped training centres strategically located across the country. There are courses covering our entire product range and as well as tailor-made and specialist equipment training, we offer a course specially designed to improve sales skills. We are also an approved provider of ACS assessment and the Certificate in Energy Efficiency for Domestic Heating.

For full details of our current courses please contact our Training Department.

Contact details

Head Office, Southern & Western Region

Vaillant Ltd., Vaillant House, Trident Close, Rochester, Kent ME2 4EZ
Telephone 01634 292300
E-mail info@vaillant.co.uk

Northern Region

Vaillant Ltd., Unit D1, Lowfields Business Park, Elland, West Yorkshire HX5 9DG
Telephone 01422 376070
Fax 01422 311986
E-mail elland@vaillant.co.uk

Sales

Telephone 01634 292310
Fax 01634 712804
E-mail sales@vaillant.co.uk

Contracts, Partnering & Leasing

Telephone 01634 292322
Fax 01634 292379
E-mail contracts@vaillant.co.uk

Technical

Telephone 01634 292392
Fax 01634 294504
E-mail technical@vaillant.co.uk

Training

Telephone 01634 292370
Fax 01634 292354
E-mail training@vaillant.co.uk

Service

Telephone 0870 6060 777
Fax 01634 294506
E-mail service@vaillant.co.uk

Mon - Fri 8.00am - 8.00pm
Sat - Sun 9.00am - 4.00pm

Website **www.vaillant.co.uk**

Total System Solution

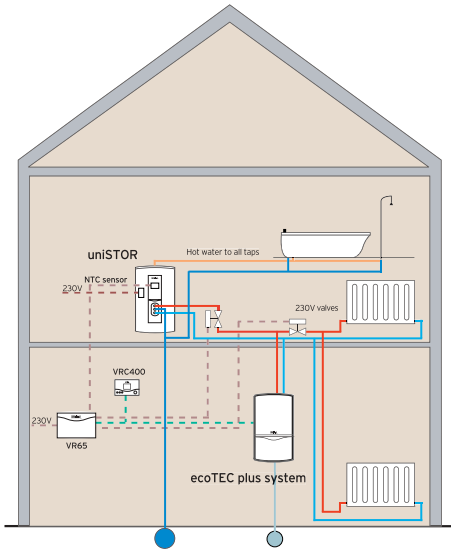

Vaillant ecoTEC system boilers and uniSTOR unvented stainless steel cylinders can now be integrated into one complete system together with the new Vaillant 'ebus' controls. This total system concept brings some unique features and benefits to the installer and the home-owner.

Benefits

- All components supplied from one manufacturer for peace of mind
- All components are compatible
- DHW temperature can be set at the boiler or at the control
- Cylinder re-charge with 'AquaCondens' system which re-charges cylinder at the most economical temperature to maintain efficiency
- Easy to integrate with underfloor heating systems
- Simple wiring
- Easy to upgrade existing systems

Which components form the total system solution?

- ecoTEC plus system boilers
- uniSTOR stainless steel cylinder (supplied with 230V DHW valve)
- 'ebus' controls e.g. VRT 360, VRC 400
- VR 65 control centre
- uniSTOR cylinder NTC (VR 10)

Note: 230V zone valves (for CH) are widely available and must be supplied separately.



VR 65 control centre

The VR 65 control centre is the heart of the total system solution. It has been designed to allow Vaillant low voltage 'ebus' controls to be integrated within traditional 230V S-plan or Y-plan type installations to provide a total system solution.

The VR 65 control centre provides the following connection points:-

- 1 x 3-port zone valve or 2 x 2-port zone valves
- 230V cylinder thermostat
- NTC for installation in uniSTOR only (instead of 230V cylinder stat)
- 230V connection
- 'ebus' connection



Technical Specification

	ecoTEC plus combi		ecoTEC pro combi	ecoTEC plus system				
	824	831	28	612	615	618	624	630
Flue Type	RSF	RSF	RSF	RSF	RSF	RSF	RSF	RSF
Maximum DHW heat output	kW	23.0	31.0	28.0	-	-	-	-
	(Btu/h)	78,500	105,800	95,500	-	-	-	-
DHW flow rate @ 35°C		9.4	12.7	11.5	-	-	-	-
Mains water pressure required for max. flow rate	bar	0.5	0.5	0.5	-	-	-	-
CH heat output range (80°C flow / 60°C return)	kW	6.7 - 19	8.7 - 24.0	9.0 - 24	4.9 - 12	4.9 - 15	6.7 - 18	8.7 - 24
	(Btu/h)	22,800 - 64,800	29,700 - 81,800	30,700 - 81,800	16,700 - 41,000	16,700 - 51,100	22,800 - 61,400	29,700 - 81,800
Heating flow / return	mm	22	22	22	22	22	22	22
cold water inlet	mm	15	15	15	-	-	-	-
DHW outlet	mm	15	15	15	-	-	-	-
Gas inlet	mm	15	15	15	15	15	15	15
Pressure relief valve discharge pipework	mm	15	15	15	15	15	15	15
Condensate drain (internal diameter min.)	mm	19	19	19	19	19	19	19
Electrical connection	V/Hz	230/50	230/50	230/50	230/50	230/50	230/50	230/50
External case height	mm	720	720	720	720	720	720	720
External case width	mm	440	440	440	440	440	440	440
External case depth	mm	335	335	335	335	335	335	369
Top clearance	mm	165	165	165	165	165	165	165
Side clearance	mm	5	5	5	5	5	5	5
Bottom clearance	mm	180	180	180	180	180	180	180
Weight approx.	kg	36.8	38.3	37.5	34.8	34.8	34.8	36.3
LPG model available		-	●	-	-	-	●	-
SEDBUK	Band	A	A	A	A	A	A	A

Vaillant Ltd.

Vaillant House ■ Medway City Estate ■ Trident Close ■ Rochester ■ Kent ME2 4EZ
Telephone 01634 292300 ■ Fax 01634 290166 ■ www.vaillant.co.uk ■ info@vaillant.co.uk